

TM - COPPER COMPRESSION TERMINAL (ONE HOLE / SHORT BARREL)

TM-10-6

Description

Purpose: Termination of copper conductors.

Characteristics: High electrical conductivity and corrosion resistance. Pad with several hole diameter options and optimum electrical contact.

Applications: Electrical panels, circuit breaker connections, motors, machines, busbars, electrical distribution boards, among others.

Material: Electrolytic copper.

Finish: Tin plated.

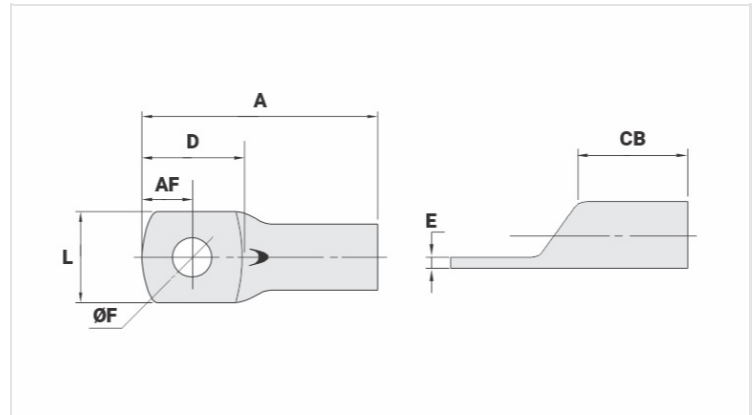

Datasheet

Conductors - Cross Section (mm²) 10

Dimensions (mm)

Hole Diameter (mm)	6,5
Screw*	
Inches	1/4
Metric	M6
L	8,5
A	23,0
CB	8,0
AF	5,0
D	11,0
E	1,5

Current (A) 101

Application Tool

Mechanical Pliers	
Model	AT-60/68
Die (AT-60)	IW-8
Hydraulic Pliers (AY/CY/AHM/AHB)	
Circunferencial Die	IU-8
Hexagonal Die	H-8

Package

Qty. / Package

100

Unit Weight (g)

2,13