

TM - COPPER COMPRESSION TERMINAL (ONE HOLE / SHORT BARREL)

TM-25

Description

Purpose: Termination of copper conductors.

Characteristics: High electrical conductivity and corrosion resistance. Pad with several hole diameter options and optimum electrical contact.

Applications: Electrical panels, circuit breaker connections, motors, machines, busbars, electrical distribution boards, among others.

Material: Electrolytic copper.

Finish: Tin plated.

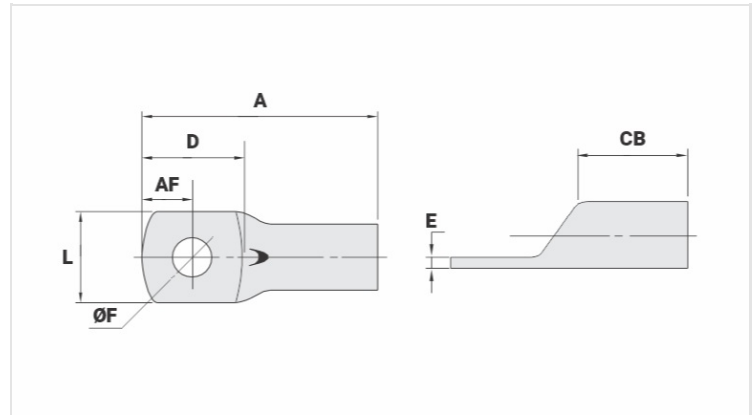

Datasheet

Conductors - Cross Section (mm²)

25

Dimensions (mm)

Diâmetro do Furo (mm)

6,5

Parafuso*

Pol.

1/4

Métrico

M6

L

12,9

A

32,0

CB

11,0

AF

6,0

D

15,5

E

2,0

Current (A)

182

Application Tool

Alicate Mecânico

Modelo

AT-60/68

Matriz (AT-60)

IW-4

Alicate Hidráulico (AY-96 / CY-96)

Matriz Circunf.

IU-4

Matriz Hexagonal

H-4

Package

Qtd / Emb

100

Peso Unit. (g)

7,20