

TM - COPPER COMPRESSION TERMINAL (ONE HOLE / SHORT BARREL)

TM-70

Description

Purpose: Termination of copper conductors.

Characteristics: High electrical conductivity and corrosion resistance. Pad with several hole diameter options and optimum electrical contact.

Applications: Electrical panels, circuit breaker connections, motors, machines, busbars, electrical distribution boards, among others.

Material: Electrolytic copper.

Finish: Tin plated.

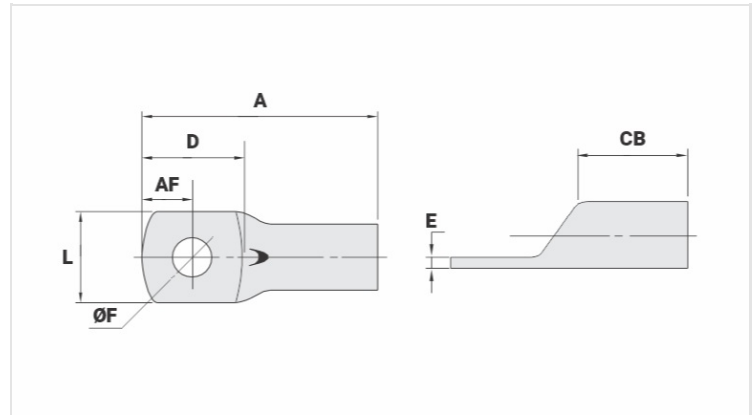

Datasheet

Conductors - Cross Section (mm²) 70

Dimensions (mm)

Diâmetro do Furo (mm)	10,5
Parafuso*	
Pol.	3/8
Métrico	M10
L	20,3
A	46,0
CB	16,5
AF	10,0
D	22,0
E	3,0

Current (A) 353

Application Tool

Alicate Mecânico	
Modelo	AT-60/68
Matriz (AT-60)	IW-26
Alicate Hidráulico (AY-96 / CY-96)	
Matriz Circunf.	IU-26
Matriz Hexagonal	H-26

Package

Qtd / Emb

50

Peso Unit. (g)

21,70