

TM - COPPER COMPRESSION TERMINAL (ONE HOLE / SHORT BARREL)

TM-400-13

Description

Purpose: Termination of copper conductors.

Characteristics: High electrical conductivity and corrosion resistance. Pad with several hole diameter options and optimum electrical contact.

Applications: Electrical panels, circuit breaker connections, motors, machines, busbars, electrical distribution boards, among others.

Material: Electrolytic copper.

Finish: Tin plated.

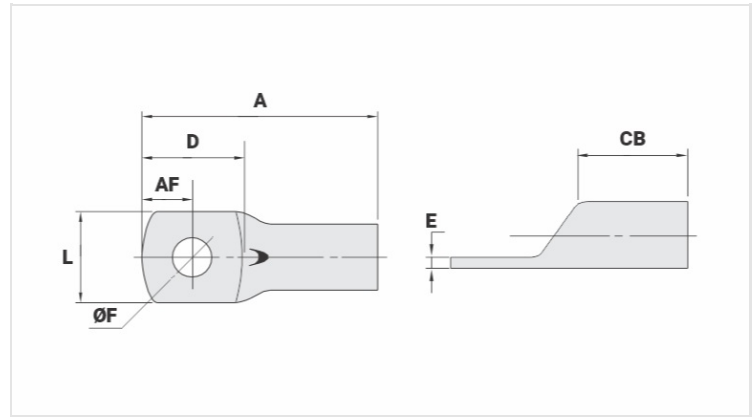

Datasheet

Conductors - Cross Section (mm²) 400

Dimensions (mm)

Diâmetro do Furo (mm)	13,8
Parafuso*	
Pol.	5/8
Métrico	M16
L	46,5
A	101,5
CB	37,0
AF	19,0
D	44,0
E	5,3

Current (A) 1085

Application Tool

Alicate Mecânico	
Modelo	-
Matriz (AT-60)	-
Alicate Hidráulico (AY-96 / CY-96)	
Matriz Circunf.	IU-40
Matriz Hexagonal	H-40

Package

Qtd / Emb

10

Peso Unit. (g)

208,80