

TPT - TUBULAR RING TYPE PRE-INSULATED TERMINALS

TPT-50-6

Description

Purpose: Termination of rigid or flexible copper cables.

Characteristics: Compression connection. High electrical conductivity and corrosion resistance.

Application: Electrical installations in general (residential, building, industrial). Circuits up to 90°C and 750V.

Material: Electrolytic copper and polypropylene insulation.

Finish: Tin plated and insulated. Application Tool: ATP-49.

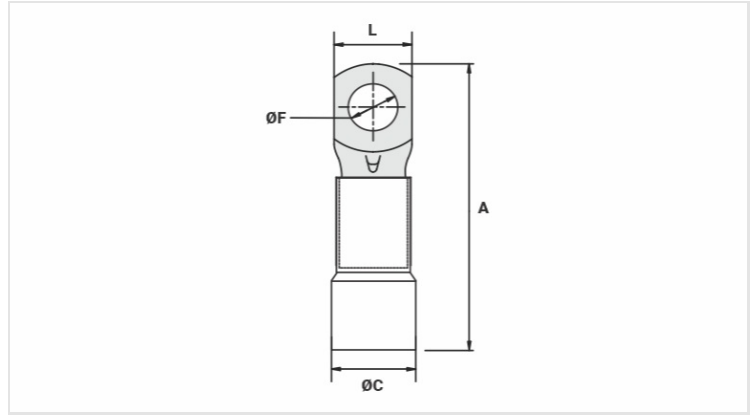

Datasheet

Insulation per DIN Standard (Color)	AZUL
Conductors - Cross Section (mm²)	50
Dimensions (mm)	
L	18,0
A	57,0
C	12,4
ØF	6,5
Maximum Current (A)	219
Package	
Qty. / Package	50
Unit Weight (g)	17,90