

**TPT - TUBULAR RING TYPE PRE-INSULATED TERMINALS**

TPT-70-8

**Description**

**Purpose:** Termination of rigid or flexible copper cables.

**Characteristics:** Compression connection. High electrical conductivity and corrosion resistance.

**Application:** Electrical installations in general (residential, building, industrial). Circuits up to 90°C and 750V.

**Material:** Electrolytic copper and polypropylene insulation.

**Finish:** Tin plated and insulated. Application Tool: ATP-49.

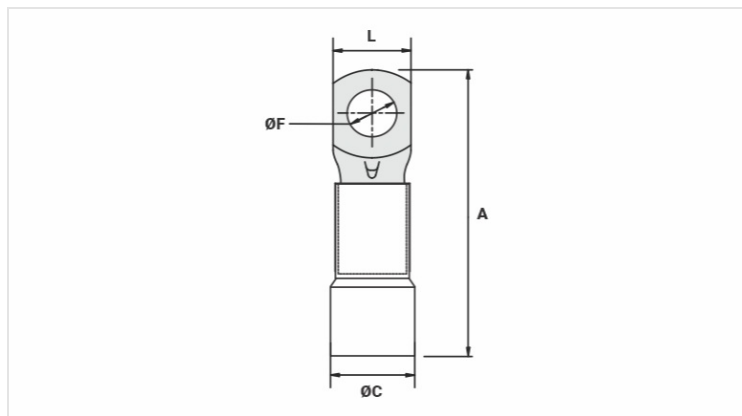

**Datasheet**

<b>Insulation per DIN Standard (Color)</b>	AMARELO
<b>Conductors - Cross Section (mm<sup>2</sup>)</b>	70
<b>Dimensions (mm)</b>	
L	20,3
A	65,0
C	14,0
ØF	8,5
<b>Maximum Current (A)</b>	281
<b>Package</b>	
Qty. / Package	50
Unit Weight (g)	24,47