

TPF - FORK TYPE PRE-INSULATED TERMINALS

TPF-2,5-3

Description

Purpose: Termination of rigid or flexible copper cables.

Characteristics: Compression connection. High electrical conductivity and corrosion resistance.

Application: Electrical installations in general (residential, building, industrial). Circuits up to 90°C and 750V.

Material: Electrolytic copper and polypropylene insulation.

Finish: Tin plated and insulated.

Application Tool: AT-10 or ATC-6.

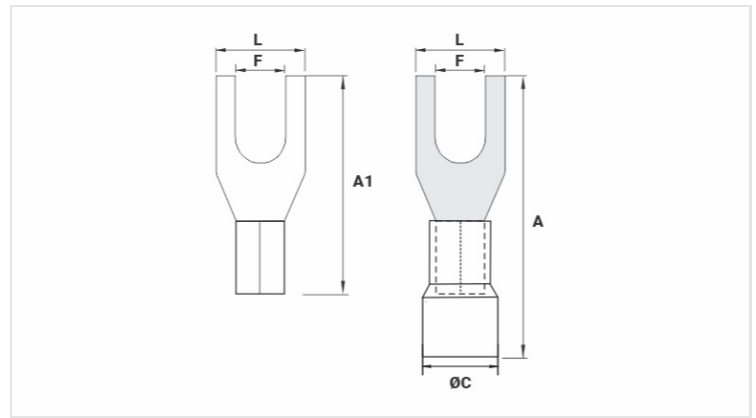

Datasheet

Insulation per DIN Standard (Color)	AZUL / BLUE
Conductor	
AWG/MCM	16 - 14
mm ²	1,5 - 2,5
Dimensions (mm)	
L	6,5
A	21,5
Ø C	6,0
F	3,3
A1	16,0
Maximum Current (A)	27
Package	
Qty. / Package	100
Unit Weight (g)	0,87