

CDP - PIERCING CONNECTOR

CDP-6

Description

Purpose: Tap of Insulated Cables, suitable for combinations aluminum to aluminum, aluminum to copper and copper to copper in overhead power distribution lines (low voltage up to 1kV).

Characteristics: Insulation piercing connection (no stripping of cable insulation required). Used with 0.6/1kV XLPE/PE insulated aluminum cables or 450/750v PVC insulated cables (without cover). It has a fuse nut to ensure a perfect connection. It has elastomeric rubbers, making the connector watertight.

Application: Overhead insulated power distribution lines.

Material: Polymer connector resistant to weather and U.V. rays. Tin plated copper contacts.

Application Tool: Star or socket wrench.

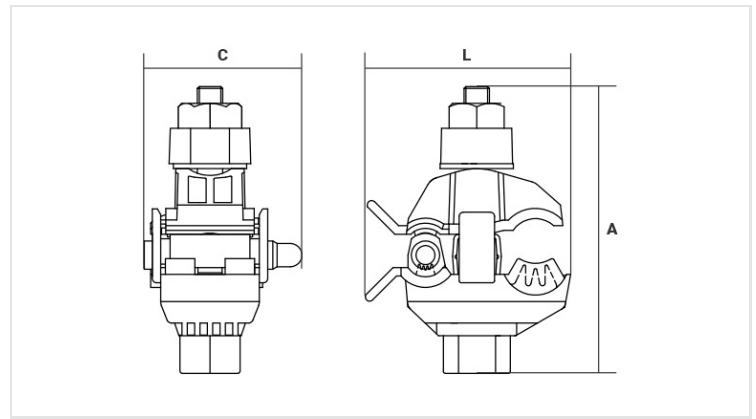

Datasheet

Conductors

Run	
mm ²	10 - 120
AWG/MCM	8 - 4/0
Tap	
mm ²	1,5 - 6
AWG/MCM	16 - 10

Figure

Dimensions (mm)

L	40,0
A	65,0
C	23,0

Package

Qty. / Package	50
Unit Weight (g)	53,38