

CDPF - PIERCING CONNECTOR FOR FLEXIBLE CONDUCTORS

CDPF-16-16

Description

Purpose: Connection between input branch (Flexible copper cable Class-4/5 - PVC insulation 450 / 750v without cover) and connection branch (multiplexed CA aluminum conductors - XLPE / PE 0.6 / 1kV - phase and neutral (insulated or bare)).

Characteristics: Connection by piercing (no need to strip the insulation from the cable). It has a shear head nut to ensure a perfect connection. It has compensation springs that ensure a constant pression in the connection.

Application: Overhead insulated electricity distribution networks.

Material: Polymer connector resistant to weather and U.V rays. Tin plated copper contacts.

Application Tool: Star or socket wrench.

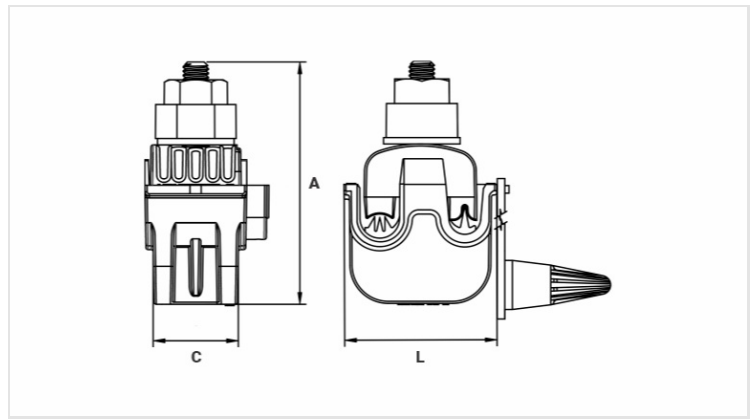

Datasheet

Conductors

Principal - CA/Cu - Classe2 (mm ²)	10 - 16
Derivação - Cu- Classe 4/5 (mm ²)	6 - 16

Dimensions (mm)

L	35,0
A	63,0
C	19,5

Package

Qtd / Emb	150
Peso Unit. (g)	61,20