

**CDPF - PIERCING CONNECTOR FOR FLEXIBLE CONDUCTORS**

CDPF-25-25

**Description**

**Purpose:** Connection between input branch (Flexible copper cable Class-4/5 - PVC insulation 450 / 750v without cover) and connection branch (multiplexed CA aluminum conductors - XLPE / PE 0.6 / 1kV - phase and neutral (insulated or bare)).

**Characteristics:** Connection by piercing (no need to strip the insulation from the cable). It has a shear head nut to ensure a perfect connection. It has compensation springs that ensure a constant pression in the connection.

**Application:** Overhead insulated electricity distribution networks.

**Material:** Polymer connector resistant to weather and U.V rays. Tin plated copper contacts.

**Application Tool:** Star or socket wrench.

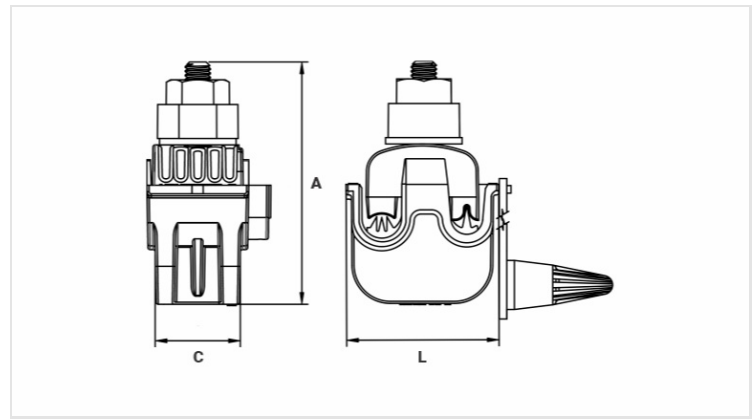

**Datasheet**

**Conductors**

Principal - CA/Cu - Classe2 (mm <sup>2</sup> )	10 - 25
Derivação - Cu- Classe 4/5 (mm <sup>2</sup> )	6 - 25

**Dimensions (mm)**

L	35,0
A	63,0
C	19,5

**Package**

Qtd / Emb	100
Peso Unit. (g)	59,00